

INFRARED WOODEN SAUNA ROOM INSTRUCTION MANUAL

Read all instructions carefully before using the wooden infrared sauna room

IG-680 EX/E400-CX



PRECAUTIONS FOR USE.....	1
PARTS NAMES.....	2
READ BEFORE INSTALLATION.....	3
INSTALLATION OF SAUNA ROOM BODY	4-7
INSTALLATION OF MAGAZINE RACK.....	8
CONTROL PANEL INSTRUCTION	9
COLOR LIGHT THERAPY SYSTEM.....	10
WARNINGS AND SUGGESTIONS FOR USE.....	11
CLEANING AND STORAGE.....	11
SPECIFICATION.....	11
SAUNA CIRCUIT DIAGRAM.....	12

ATTENTION

- ※Read all instructions before using this appliance.
- ※Serious injury may result if warnings and instructions below are not observed.
- ※When using an electrical appliance, basic precautions should always be followed, including the following:

DANGER

To reduce the risk of burns, fire, electric shock, or injury to persons.

- ※Connect the power cord to a properly grounded outlet only.
- ※Use this appliance only for its intended use as described in this manual. Do not use attachments not recommended by the manufacturer.
- ※Always unplug this appliance from the electrical outlet immediately after using.
- ※Keep the electrical cord away from heated surfaces.
- ※Heaters shall not be subjected to water spray; shower heads shall not be installed within the sauna room.
- ※If the temperature limiting control reset switch trips frequently, a qualified service person should be contacted.
- ※Never operate this appliance if it has a damaged cord or plug, if it is not working properly, or if it has been dropped or damaged. For technical support or questions on operating the sauna please call the Saunatec National Customer Service Center toll-free at (888)-780-4427; or email the Service Center at techsupport@saunatec.com.

WARNING

- ※If you have any health problem or condition, consult your physician for permission to use the sauna room. (“health problem” includes but is not limited to: acute diseases, malignant tumors, high blood pressure, heart disease, allergic dermatitis, pregnancy, etc.)
- ※The sauna room should not be used by children.
- ※Should you have any abnormal feeling with your body while using the sauna, immediately exit the sauna.
- ※If you feel uncomfortable while using the sauna, stop immediately and consult with your doctor.
- ※The use of alcohol, drugs, or medication is capable of greatly increasing the risk of fatal hyperthermia.
- ※Discontinue use if nervousness, tremor, headache, feeling of sickness or nausea occurs.

HYPERTHERMIA

Prolonged exposure of the user in the sauna room is capable of inducing hyperthermia.

Hyperthermia occurs when the internal temperature of the body reaches a level several degrees above the normal body temperature of 98.6°F. The symptoms of hyperthermia include an increase in the internal temperature of the body, dizziness, lethargy, drowsiness, and fainting.

The effects of hyperthermia include:

- a) Failure to perceive heat
- b) Failure to recognize the need to exit the room
- c) Unawareness of impending heat
- d) Fetal damage in pregnant women
- e) Physical inability to exit the room
- f) Unconsciousness

PARTS NAMES

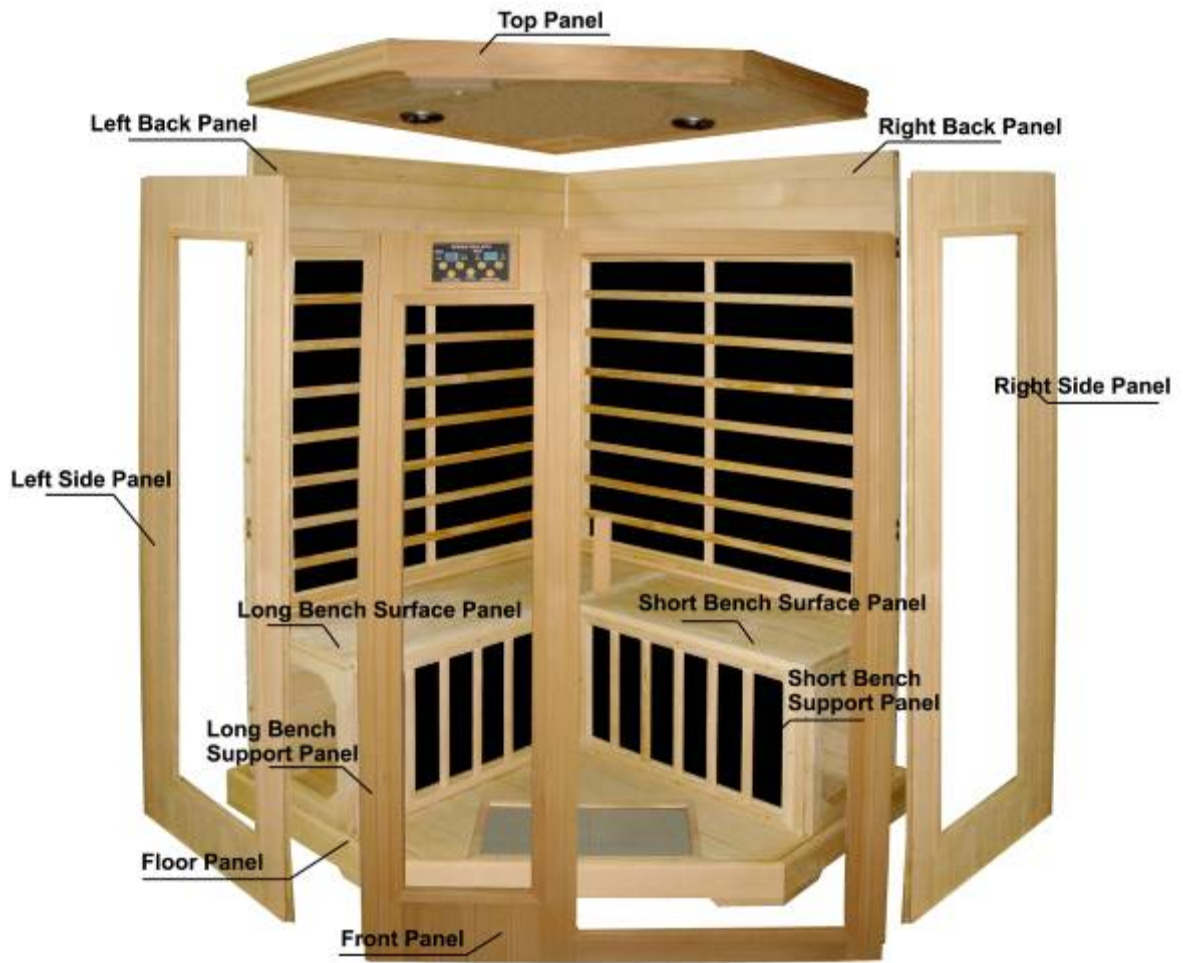

READ BEFORE INSTALLATION:

- ※ Each panel is heavy. Be careful to avoid injury when installing, especially the top panel.
- ※ Two adults are required for the installation of sauna room.
- ※ There are metal plates with pins or a slots on the sides of each panel. They will be interlock the panels together. The panel with the slot should be lifted up about 4 inches (10cm) higher than the panel with the pin (Refer to Picture 1); place the slot panel against the panel with pin (Refer to Picture 2), and then slide down the panel until the two panels are equal in height (Refer to Picture 3). If they are not equal in height or there is an obvious gap between the two panels, that means they are not properly attached, and you should try again.

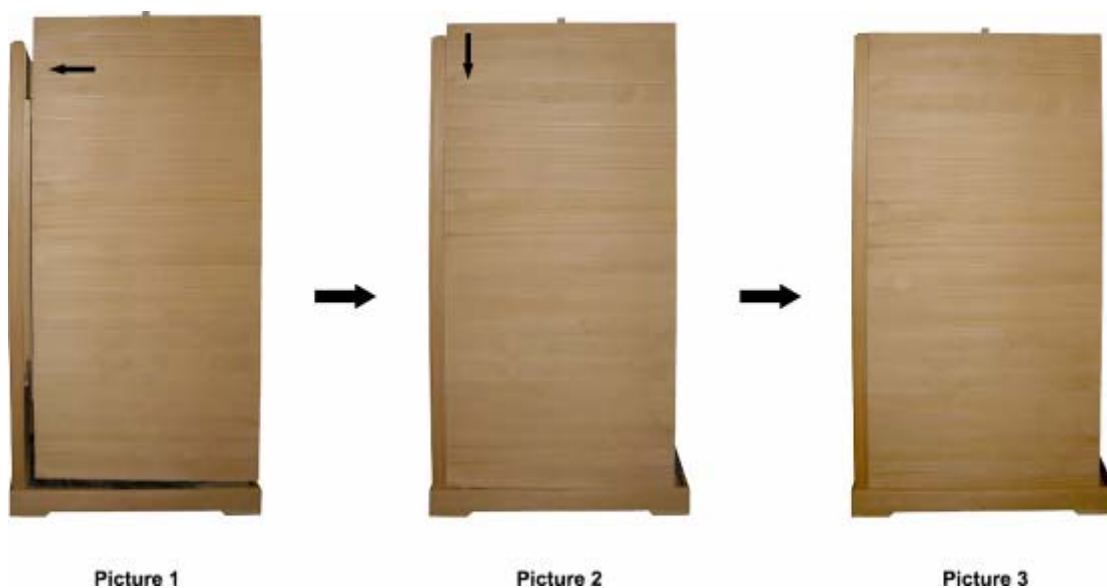

The panels should be installed in the following order:

- ※ Floor Panel → Right Back Panel → Left Back Panel → Right Side Panel → Left Side Panel → Long Bench Support Panel → Short Bench Support Panel → Long Bench Surface Panel → Short Bench Surface Panel → Front Panel → Top Panel

INSTALLATION OF SAUNA ROOM BODY

1. Place the floor panel in the desired location on a level surface (Note: The floor panel must be level before installing wall and ceiling panels. If the surface is not level you may need to shim the bottom panel to get level.)
※The neo-angle on the floor is the front wall.



2. Place the right back panel in the slot of floor panel.



3. Place the left back panel in the slot of floor panel.



4. Place the right side panel and the left side panel in the slot of floor panel.



5. Place the bench support panel first and then place the bench surface panel into the sauna room.

- ※ On larger sauna rooms with more than one bench, rotate the wooden bench supports away from the side walls.
- ※ The side with Heating Film should be faced outside.
- ※ Make sure the two side slots of the long & short bench support panel are inserted into the corresponding groove at both sides smoothly and completely. (Refer to picture 1)
- ※ Connect the power connector at the Floor Panel and that of the left (or right) back Panel at the bottom on right side into the white box A. (Refer to picture 2)
- ※ Connect the power connector at the back of Long (or Short) Bench Support Panel and that of the left (or right) back Panel at the bottom on right side into the white box A. (Refer to picture 2)
- ※ Place the Bench Surface Panel on the Bench Support Panel and slide toward the Back Wall until half. (Refer to picture 2)
- ※ Connect the power connector at the back of Long (or Short) Bench Surface Panel and that of the left (or right) back Panel at the bottom on right side into the white box B. (Refer to picture 3)
- ※ Place the Bench Surface Panel on the Bench Support Panel and slide toward the Back Wall until flush to the Back Wall. (Refer to picture 4)



Picture 1



Picture 2



Picture 3

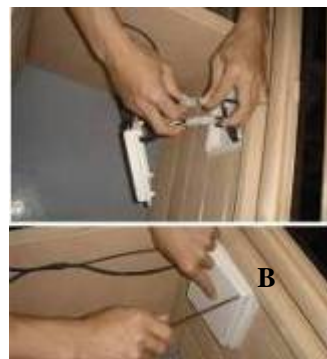

Picture 4

6. Place the front panel in the slot of floor panel, then lock the two inside latches between front and right side panel and between front and left side panel.



7. Place the top panel on the five side panels. Make sure the connection wires of three side panels (left back, right back & front) protrudes through the corresponding holes of the top panel.

- ※ Make sure the top panel's arched side is facing to the front.
- ※ Make sure the wire is through each hole smoothly and completely.
- ※ Make sure the trim of the top panel fits completely around the five side panels.

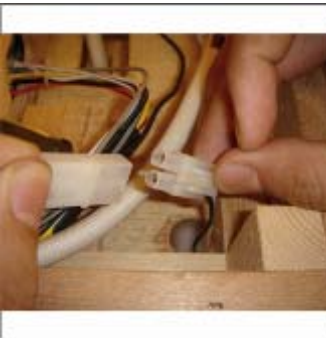

8. Make sure each of the lead wires on the top of the left back, right back and front panels is protruding through the top panel; then plug each of the three lead wires into the three connectors of the top panel.

WARNING: ELECTRIC SHOCK HAZARD

Do not plug cord into electrical outlet before connecting the plugs.

9. Connect the power connector according to following 3 pictures before plug in.



10. The power cord is located at the bottom of the back panel. Simply plug into appropriate household outlet when ready to use the sauna. Notice the plug type of your sauna room: Sauna models IG-510 & 520 & 570 have a 15 amp/120-volt plug; Models IG-530 & 540 & 580 have a 20 amp/120-volt plug.



INSTALLATION OF MAGAZINE RACK

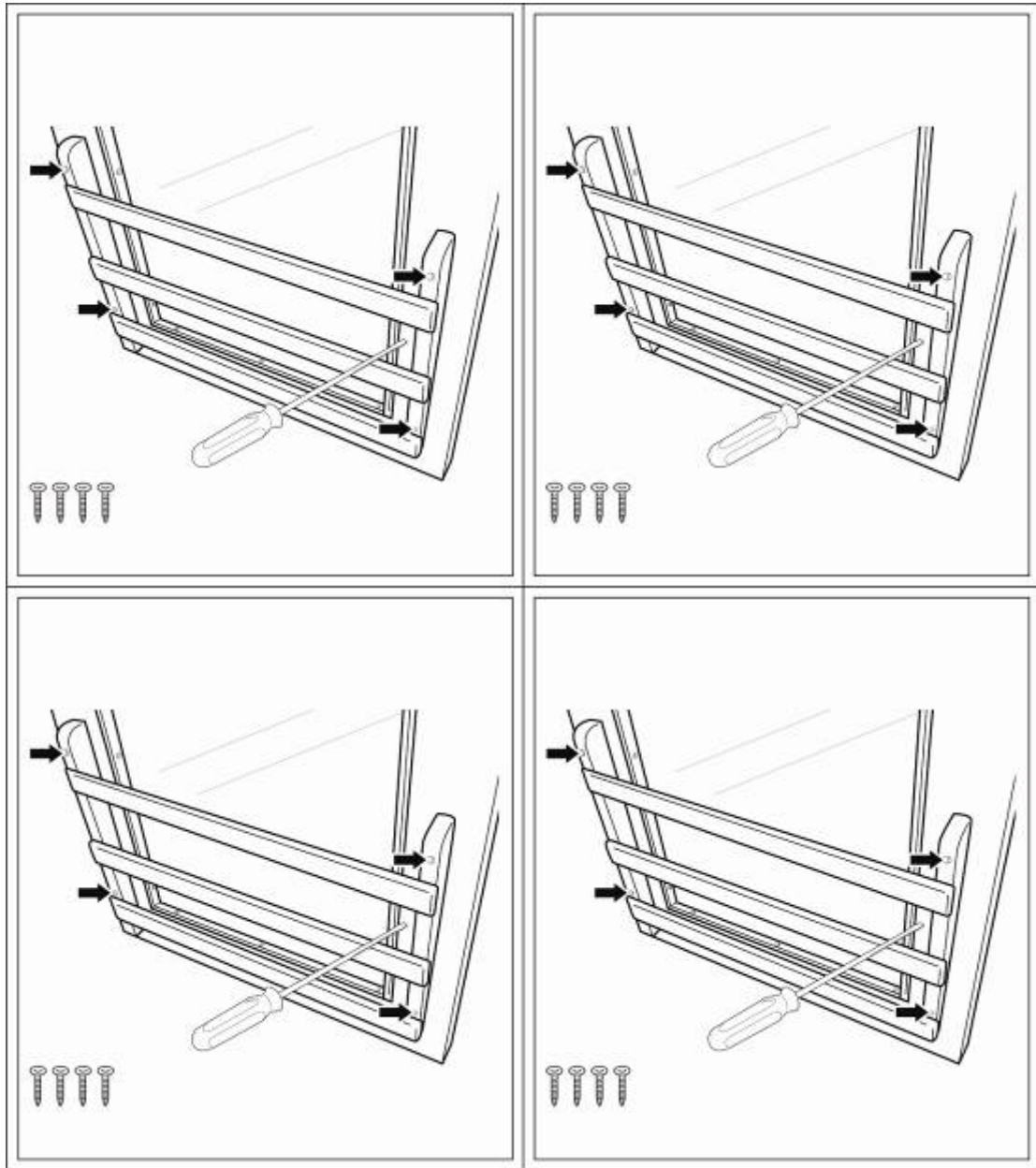

CONTROL PANEL INSTRUCTION

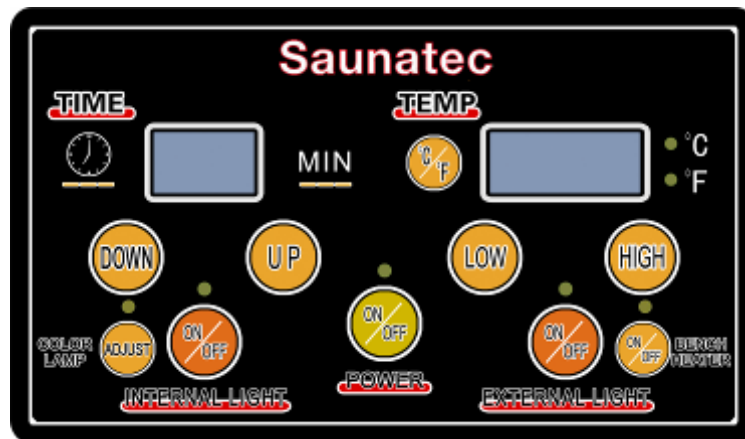

1. Press "POWER" to switch on or off.
2. "TIME" refers to control of operating time and indicates the amount of time remaining.
 - ※ Once power is on, the default amount of operating time is at 45 minutes.
 - ※ Press "UP" and "DOWN" to adjust and set time of use; pressing once will increase or reduce in 5 minute increments. The maximum operating time is 60 minutes.
 - ※ After time of use is set, the number will flash for about three seconds.
 - ※ After the set "Time" stops flashing, the number indicated will show operating time remaining.
3. "TEMP" refers to control of the "set temperature" and also indicates the "actual temperature" inside sauna room.
 - ※ "° C/° F" refer to the switching of "° C" and "° F".
 - ※ Once the control is turned on, the indicated temperature of use defaults to 120 degrees F (50° C).
 - ※ Press "HIGH" or "LOW" to adjust and set temperature in sauna room; pressing once will increase or reduce in one degree increments. The maximum set temperature is 150° F/65° C.
 - ※ After temperature of use is set, the number of temperature will flash for about 5 minutes.
 - ※ After the numbers of the set temperature stop flashing, the number indicated will show actual temperature inside sauna room.
4. Press "External Light" to switch on or off.
5. Press "Internal Light" to switch on or off.
6. Press "Bench Heater" to switch on or off.

OPERATING INSTRUCTIONS FOR COLOR LIGHT THERAPY SYSTEM

1. To activate the color light therapy system press “ADJUST” on the sauna control panel. Upon turning the system on, the color light system will go into an automatically cycling mode, changing color every 8 seconds:

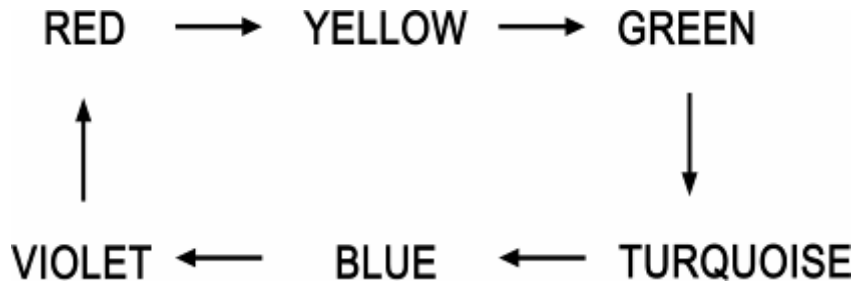

2. Press “ADJUST” 2X: Light system will glow GREEN
3. Press “ADJUST” 3X: Light system will glow RED
4. Press “ADJUST” 4X: Light system will glow BLUE
5. Press “ADJUST” 5X: Light system will glow YELLOW
6. Press “ADJUST” 6X: Light system will glow TURQUOISE
7. Press “ADJUST” 7X: Light system will glow VIOLET
8. Press “ADJUST” 8X: Light system will turn OFF
9. Color Light System automatically goes off if Power is turned OFF.

WARNINGS AND SUGGESTIONS FOR USE

Please read carefully the following warnings, to reduce the risk of burns, fire, electric shock, or injury to persons:

- ※Do not put the sauna room in a moist environment.
- ※Place room on level surface.
- ※Do not repair the product by yourself. Contact the Saunatec National Customer Service Center toll-free at 1-888-780-4427, or email at techsupport@saunatec.com
- ※Do not disassemble the product by yourself except as indicated in the manual.
- ※Do not spray the heater with water.
- ※Do not use any sharp tools on or near the heaters (severe damage may result).
- ※Do not use the product for any other purpose than originally designed and intended.
- ※Do not directly touch the heater with hands or body for extended periods of time.
- ※Do not use continuously for more than one hour.

SUGGESTIONS FOR USE

- ※When enjoying a sauna room bath, it is suggested to turn power on at least 15 minutes beforehand. After 15 minutes of preheating, the temperature inside the sauna room should reach about 105 degrees F (40° C) ; at this stage most people find the sauna a comfortable temperature to begin the sauna bath. The temperature will continue to rise to the set temperature.
- ※If it feels too hot during use, adjust the temperature down, open the vent or open the door for fresh air.

CLEANING

Clean the outside and inside with a damp cloth, or clean with a small amount of hand-soap mixed with warm water if necessary. Do not use benzene, alcohol, or strong cleaning chemicals on sauna.

Note: Some chemicals can damage wood material and the protection layer that is on the outside wood surface.

STORAGE

Do not store product in a moist environment or in direct sunlight.

SPECIFICATION

Product Name	Infrared Wooden Sauna Room
Product No.	IG-580
Product Size	152×68/118/68×195(H)cm (60 " ×27 " /46 " /27 " ×77 ")
Weight	ca. 177kg (390lbs.)
Power Supply	AC120V
Power Consumption	2130W
Wooden Material	<input type="checkbox"/> Canadian Hemlock <input type="checkbox"/> Canadian Red Cedar

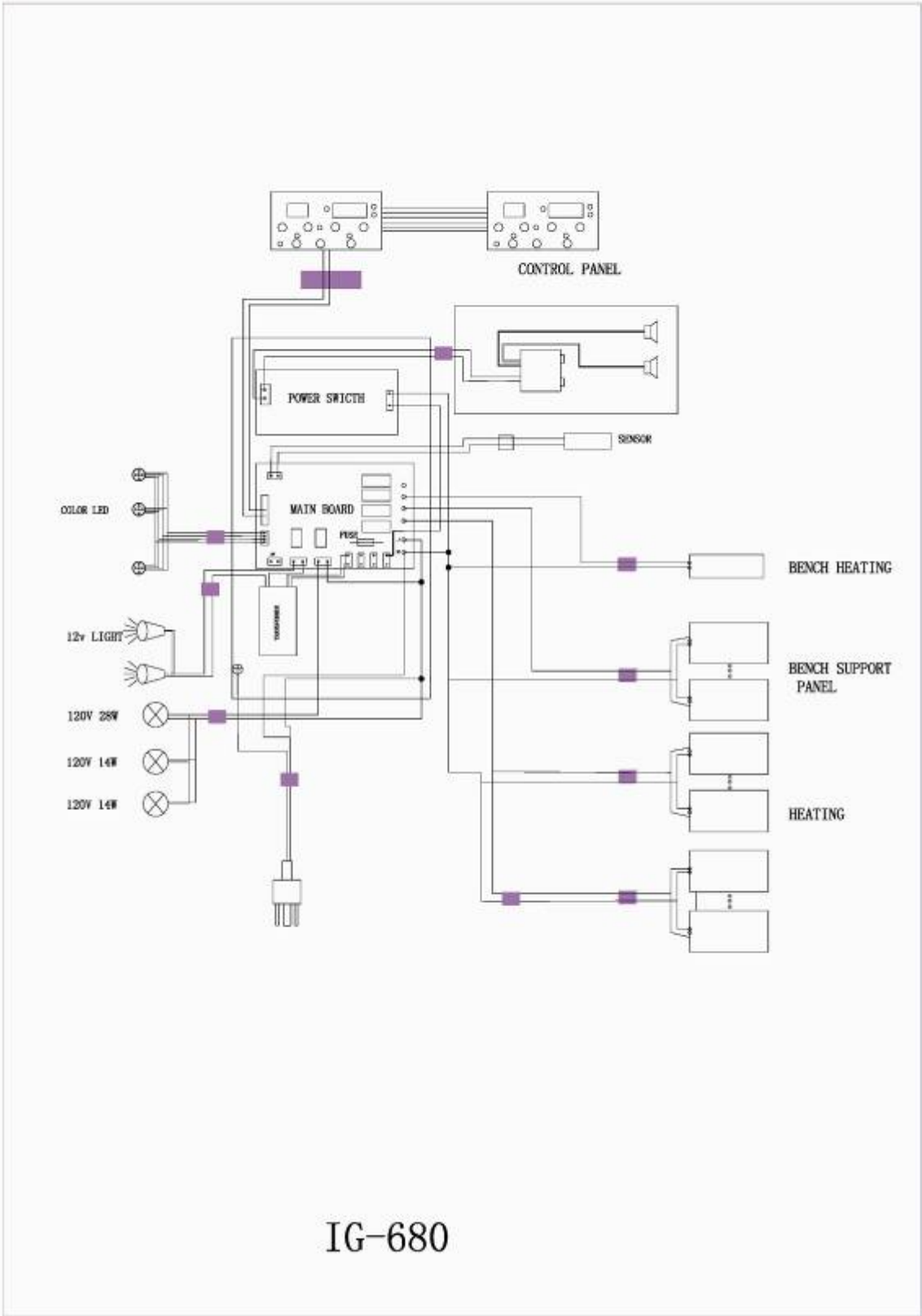

IG-680

 <p>WARNING</p> <p>REDUCE THE RISK OF ELECTROCUTION It is Forbidden To Bring Wet Towels Into Sauna</p>	 <p>WARNING</p> <p>Install In A Dry Environment</p>
 <p>WARNING</p> <p>REDUCE THE RISK OF FIRE Do Not Install Closer Than 12.7mm (0.5 inches) To A (Vertical/Horizontal) Surface</p>	 <p>WARNING</p> <p>REDUCE THE RISK OF ELECTROCUTION AND BURNS Do Not Operate Unless Guard Is In Place.</p>
 <p>WARNING</p> <p>REDUCE THE RISK OF FIRE Do Not Place Combustible Material On Heater At Any Time.</p>	 <p>CAUTION</p> <p>REDUCE THE RISK OF ELECTROCUTION Disconnect All Supply Connections Before Servicing</p>
 <p>WARNING</p> <p>REDUCE THE RISK OF OVERHEATING</p> <ol style="list-style-type: none"> 1. Exit immediately if uncomfortable, dizzy, or sleepy. Staying too long in a heated area is capable of causing overheating. 2. Supervise children at all times. 3. Check with a doctor before use if pregnant, in poor health, or under medical care. 4. Breathing heated air in conjunction with consumption of alcohol, or drugs, or medication is capable of causing unconsciousness. 	 <p>WARNING</p> <p>Excess Exposure Can Be Harmful To Health. Persons With Poor Health Should Consult Their Physicians Before Using Sauna</p>